

Fiche technique :

# MRT 3570 ES

**VISION +**



Capacities		Métrique
Max. capacity		7000 kg
Max. lifting height		34.70 m
Max. outreach		28 m
Weight and dimensions		
Overall width	b1	2.50 m
Overall height	h17	3.26 m
Overall cab width	b4	0.96 m
Ground clearance	m4	0.39 m
Wheelbase	y	3.75 m
Frame levelling longitudinal +/-		3 °
Tilt-up angle	a4	13 °
Tilt-down angle	a5	108 °
Turret rotation		360 °
Overall weight		24000 kg
Forks length / width / section	l / e / s	1200 mm x 125 mm x 60 mm
Wheels		
Standard tyres		17,5_R25
Drive wheels (front / rear)		2 / 2
Steering mode		2 wheel steer, 4 wheel steer, Crab mode
Stabilisers		
Stabs Type		Telescopic Triplex
Controls with stabs		Stabs Commands Individual or Simultaneous
Engine		
Engine brand		Yanmar
Engine norm		Stage V / Tier 4
Engine model		4TN107FTT-6SMU2
I.C. Engine power rating / Power (kW)		157.34 kW / 155 kW
Max. torque / Engine rotation (min)		805 Nm @ 1500 rpm
Number of cylinders - Capacity of cylinders		4 - 4567 cm <sup>3</sup>
Engine cooling system		Water cooled
Number of batteries / Battery / Batteries capacity		2 x 12 V / 120 Ah
Battery starting current		(EN)850 A
Transmission		
Transmission type		Hydrostatic with CVT
Gearbox		Speedshift
Max. travel speed		40 km/h
Drawbar pull (Laden)		9300 daN
Parking brake		Automatic negative parking brake
Service brake		Oil-immersed multi-discs braking on front & rear axles
Performances		
Gradeability (laden / unladen)		29 % / 38.70 %
Hydraulics		
Hydraulic pump type		Variable displacement pump
Hydraulic flow		185 l/min
Hydraulic Pressure		350 bar
Tank capacities		
Engine oil		13 l
Hydraulic oil		300 l
Fuel tank		320 l
Diesel Exhaust fluid (AdBlue® type)		24 l
Noise and vibration		
Noise at driving position (LpA)		68 dB
Environmental noise (LwA)		109 dB
Vibration to whole hand/am		< 2.50 m/s <sup>2</sup>
Miscellaneous		
Steering wheels (front / rear)		2 / 2
Controls		2 Joysticks
Safety cab homologation		Cabin ROPS - FOPS Level 2
Attachment recognition system (E-Reco)		Standard

## MRT 3570 ES - Schémas d'encombrement

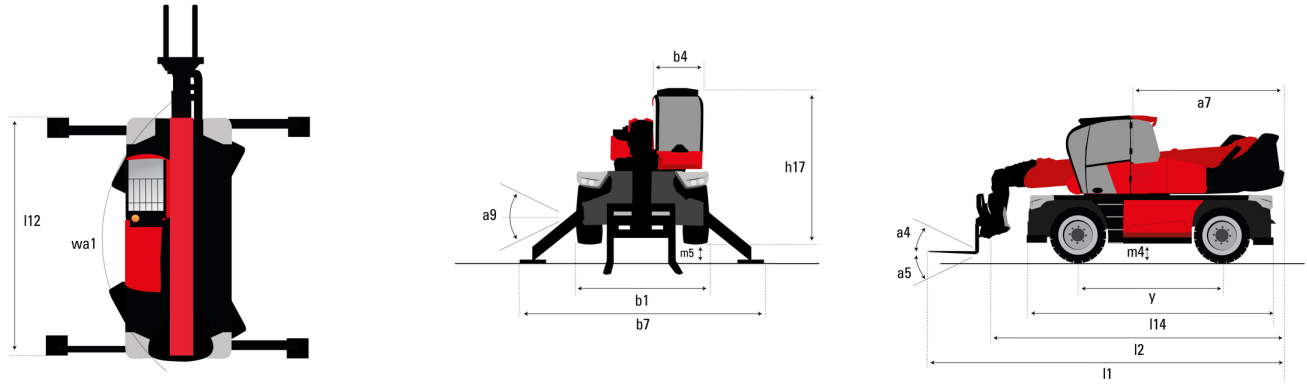

Autres données		Métrique	
Overall length (with forks)		l1	10.06 m
Length to face of forks		l2	8.86 m
Length of frame		l14	6.80 m
Wheelbase		y	3.75 m
Ground clearance		m4	0.39 m
Counterweight offset (turret at 90°)		a7	3.75 m
Tilt-up angle		a4	13 °
Tilt-down angle		a5	108 °
Overall length at stabilisers		l12	6.50 m
External turning radius (over tyres)		Wa1	5.16 m
Overall width		b1	2.50 m
Overall width with stabilisers extended		b7	7.42 m
Overall cab width		b4	0.96 m
Overall height		h17	3.26 m
Frame levelling corrector		a9	+/- 8 °
Ground clearance under front tires on stabilizers		m5	0.45 m

## MRT 3570 ES - Abaques

Machine on tyres with forks Metric

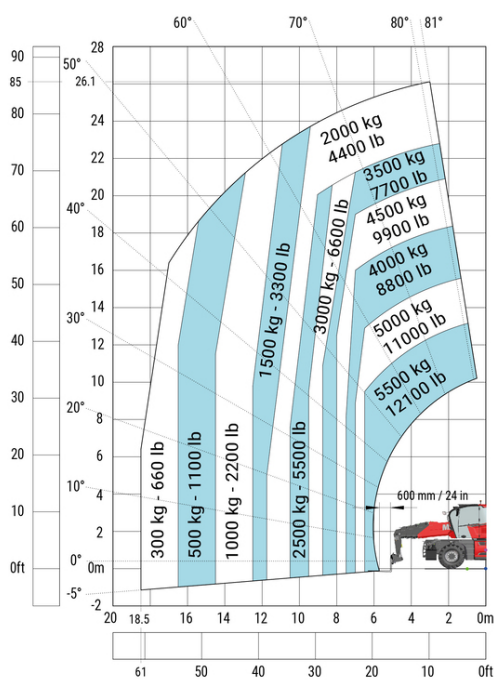

Machine on lowered stabilisers with forks Metric

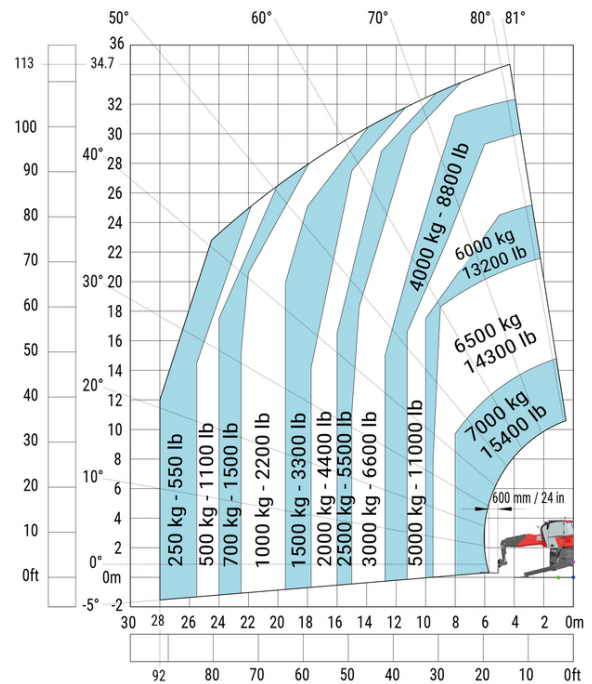

Machine on lowered stabilisers with 1500 kg jib Metric

Machine on lowered stabilisers with 365 kg platform Metric

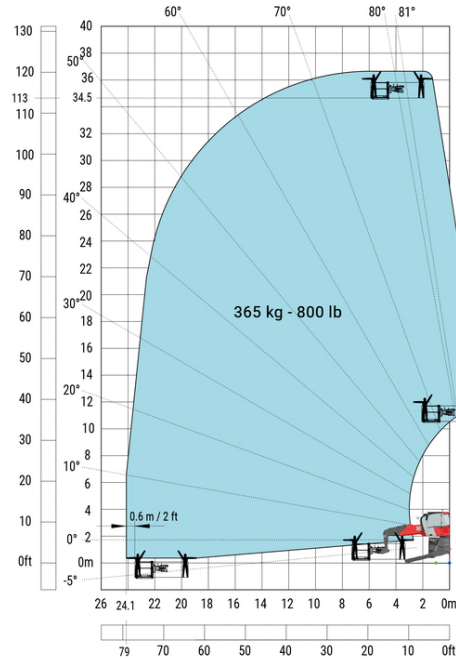
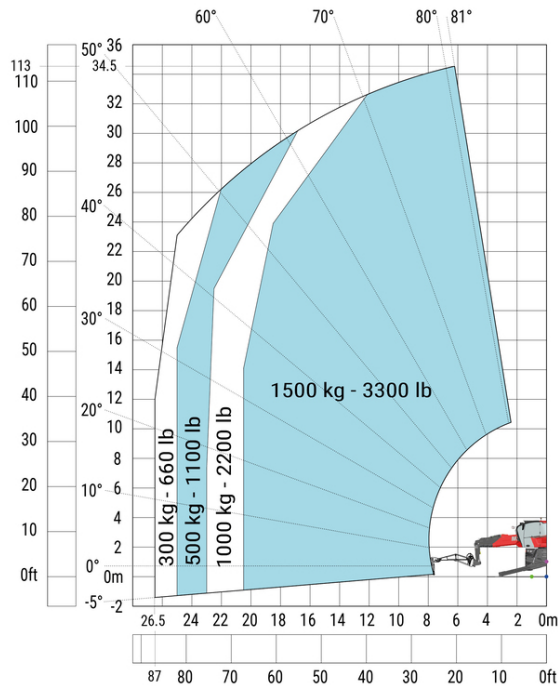

Machine on lowered stabilisers with 3D positive Metric

Machine on lowered stabilisers with hook 9000 kg (Metric)

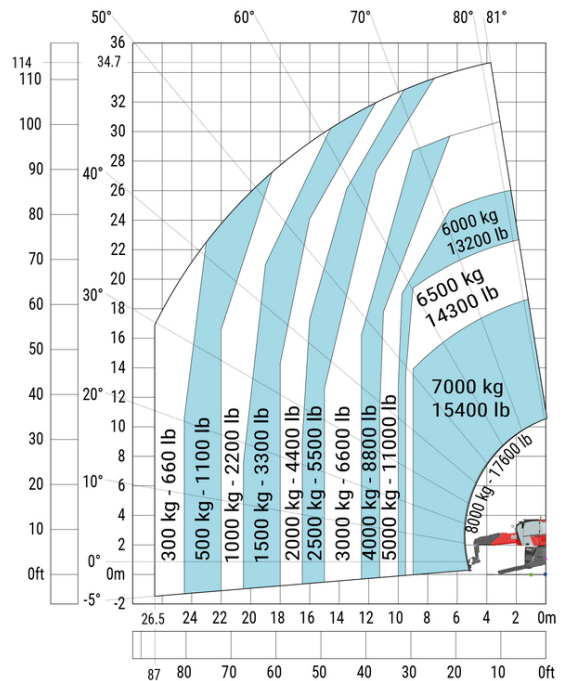
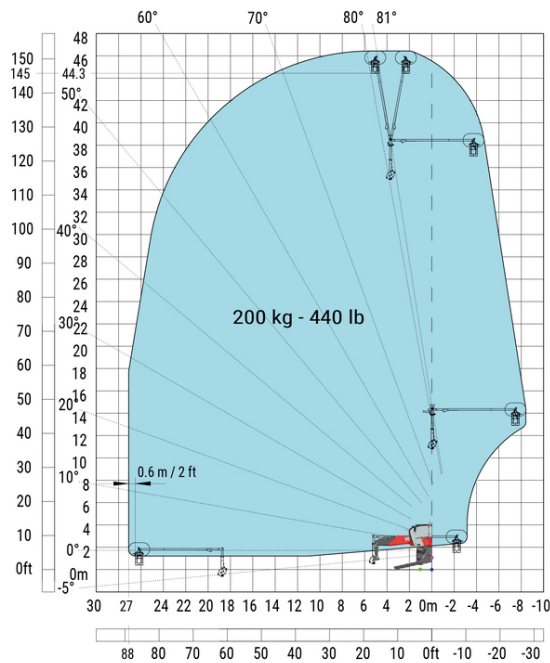

### Machine on lowered stabilizers with winch 7200 kg (metric)

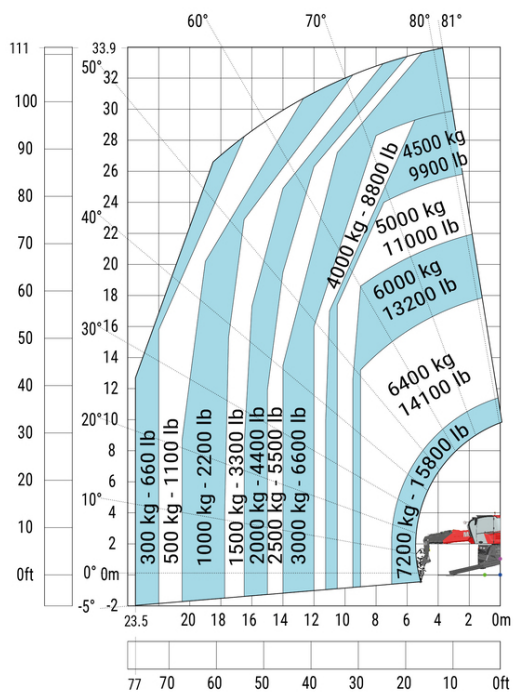



**Siège Social**

B.P. 249 - 430 rue de l'Aubinière

44150 Ancenis Cedex - France

Tel: +33 (0)2 40 09 10 11 - Fax: +33 (0)2 40 09 10 97

[www.manitou.com](http://www.manitou.com)



Cette publication présente le descriptif des versions et possibilités de configuration des produits Manitou qui peuvent différer en équipement. Les équipements présentés dans cette brochure peuvent être de série, en option, ou non disponibles suivant les versions. Manitou se réserve le droit, à tout moment et sans préavis, de modifier les spécifications décrites et représentées. Les spécifications portées n'engagent pas le constructeur. Pour plus de détails, contactez votre concessionnaire Manitou. Document non contractuel. Présentation des produits non contractuelle. Liste des spécifications non exhaustive. Les logos ainsi que l'identité visuelle de l'entreprise sont la propriété de Manitou et ne peuvent être utilisés sans autorisation. Tous droits réservés. Les photos et schémas contenus dans la présente brochure ne sont fournis qu'à des fins de consultation et à titre indicatif.

Manitou BF SA - Société anonyme à conseil d'administration - Capital social : 39 668 399 euros - 857 802 508 RCS Nantes